

## THERMOPLAN B & W 3 CTM 2 + RS

Quality at the touch of a button.  
World-class milk. Swiss made modularity.

### FEATURES + BENEFITS

- Made to last – the Black&White 3 is built to last – durable aluminium grinders, ceramic burrs and a solid stainless steel chassis deliver durability and reliability. Clever modularity also allows front-end module access, minimising down time.
- Versatile and customisable – a wide range of popular drinks and a customisable LED colour touch screen means the B&W3 can help you deliver the complete coffee offer.
- Quality drinks every time – patented milk technology and the finest quality components guarantee that every B&W coffee will be as incredible as the last. This unique milk system prepares creamy, firm and consistent milk foam without the requirement for an annual Pressure Vessel Inspection.
- Key features – built-in 6 litre fridge, automated cleaning, 13amp power supply, Pressure Vessel Inspection not required and exchangeable modular design.



### KEY STATISTICS

| **Product:** Coffee. Tea. Milk

| **Power (watts):** 2900

| **Milk:** Auto

**Product code:** 8558

**THERMOPLAN**  
**B&W3 CTM2 + RS**

Quality at the touch of a button.  
World-class milk. Swiss made modularity.

**CAPACITY AT PEAK**



Medium  
volume





**CAPACITY PER DAY**



Medium  
volume

**RECOMMENDED PRODUCTS**

Quarterly Cleaning Pack  
Product code: CLESCH0591

Water connection	2-4 BAR isolated 15mm feed, 3/4" BSP screw fitting	
Filter type	Brita Purity 600/1200 C50	
Waste	1.5" downpipe to P-trap, minimum length 8"	
Power (watts)	2900	
Power requirements	2 x 230Vac 13A standard 3-pin sockets	
Breaker	B	
Drinks dispensed simultaneously	N/A	
Milk option	Auto	
Product	Coffee. Tea. Milk	
Weight (kg)	77.5	
Dimensions w x d x h (mm)	600 x 600 x 700	

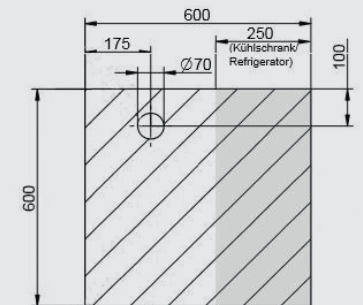
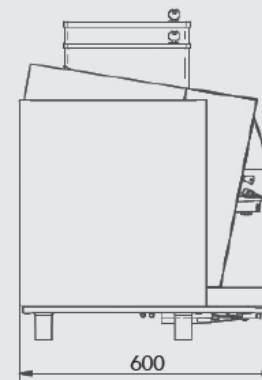
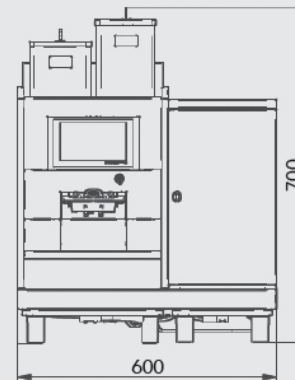

Hole is required through the counter